

vtech[®]
baby

Instruction Manual

Soothing Starlight Igloo



INTRODUCTION

Relax with the **Soothing Starlight Igloo!** Take Penguin out and about, then tuck it inside the igloo at night to activate soft lights. If baby grows restless, the igloo responds and helps soothe your little one!

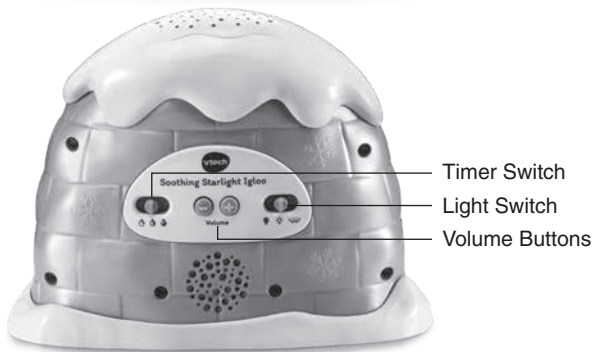
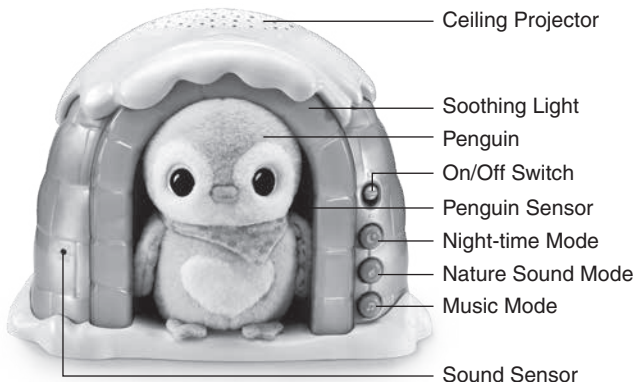

INCLUDED IN THIS PACKAGE

- VTech® Soothing Starlight Igloo
- Penguin
- Quick Start Guide

WARNING

All packing materials such as tape, plastic sheets, packaging locks, removable tags, cable ties, cords and packaging screws are not part of this toy and should be discarded for your child's safety.

NOTE

Please save this Instruction Manual as it contains important information.

WARNING

Keep this soft toy out of the sleeping environment for babies under twelve months to avoid suffocation risk.

NOTE

The **Soothing Starlight Igloo** uses IR technology that may not work well in full sunlight conditions. Please do not use the toy in direct sunlight.

Unlock the packaging locks:

- ① Rotate the packaging lock 90 degrees anticlockwise.
- ② Pull out the packaging lock and discard.

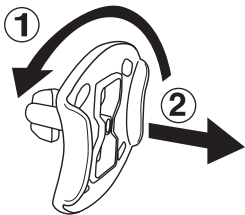

GETTING STARTED

Battery Removal and Installation

1. Make sure the unit is turned **OFF**.
2. Locate the battery cover on the bottom of the unit. Use a screwdriver to loosen the screw and then open the battery cover.
3. If used batteries are present, remove these batteries from the unit by pulling up on one end of each battery.
4. Install 2 new AA (AM-3/LR6) batteries following the diagram inside the battery box. (For best performance, alkaline batteries or fully charged Ni-MH rechargeable batteries are recommended).
5. Replace the battery cover and tighten the screw to secure.

WARNING:

Adult assembly required for battery installation.

Keep batteries out of reach of children.

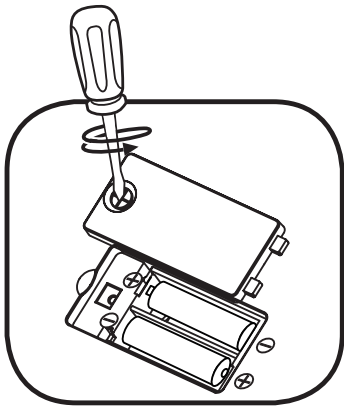

IMPORTANT: BATTERY INFORMATION

- Insert batteries with the correct polarity (+ and -).
- Do not mix old and new batteries.
- Do not mix alkaline, standard (carbon-zinc) or rechargeable batteries.
- Only batteries of the same or equivalent type as recommended are to be used.
- Do not short-circuit the supply terminals.
- Remove batteries during long periods of non-use.
- Remove exhausted batteries from the toy.
- Dispose of batteries safely. Do not dispose of batteries in fire.

RECHARGEABLE BATTERIES:

- Remove rechargeable batteries (if removable) from toy before charging.
- Rechargeable batteries are only to be charged under adult supervision.
- Do not charge non-rechargeable batteries.

Disposal of batteries and product



The crossed-out wheellie bin symbols on products and batteries, or on their respective packaging, indicates they must not be disposed of in domestic waste as they contain substances that can be damaging to the environment and human health.



The chemical symbols Hg, Cd or Pb, where marked, indicate that the battery contains more than the specified value of mercury (Hg), cadmium (Cd) or lead (Pb) set out in the Batteries and Accumulators Regulation.



The solid bar indicates that the product was placed on the market after 13th August, 2005.

Please dispose of your product and batteries responsibly.

In the UK, give this toy a second life by disposing of it at a small electricals collection point* so all of its materials can be recycled.

Learn more at:

www.vtech.co.uk/recycle

www.vtech.com.au/sustainability

* Visit www.recyclenow.com to see a list of collection points near you.

ACTIVATE NORMAL PLAY MODE

This product is in Try-Me mode in the package. To activate normal play mode, please press the **Volume Buttons** or slide the **Timer** or **Light Switch**.

PRODUCT FEATURES

1. On/Off Switch

To turn the unit **On**, slide the **On/Off Switch** to the **On** (⏻) position. To turn the unit **Off**, slide the **On/Off Switch** to the **Off** (●) position.



2. Timer

Slide the **Timer** to choose 15, 30, or 45 minutes of play. When the time is up the unit will automatically power down.



3. Volume (+ / -) Buttons

Press the + or - button to adjust the volume.



4. Light Switch

When the penguin is not in the igloo: Slide the Switch to choose between the following light modes:



Off - turns the lights off with sound playing.



Soothing Light - turns the soft blue light on with sound playing.



Ceiling Projection - turns the projector lights on with sound playing.



When the Penguin is placed into the Igloo: Both the Soothing Light and Ceiling Projection turn on, regardless of what light mode was previously selected.

5. Soothing Light

The Soothing Light will dim after 5 minutes.



6. Automatic Shut-Off

The **VTech® Soothing Starlight Igloo** will automatically power down after the selected time to preserve battery life. The unit can be turned **On** again by pressing a **Mode Button** on the front of the unit, or either of the **Volume Buttons** on the back. The igloo will also reactivate when the sensor detects baby's cry.

7. Sound Sensor

When little ones are upset, the **Soothing Starlight Igloo** turns **On** automatically to play lullabies, melodies and calming nature sounds. The Sound Sensor will turn **off** automatically after 8 hours.

ACTIVITIES

1. Penguin Sensor

The **Sensor** will activate the soothing lights or ceiling projector when you place the **Penguin** inside the igloo. Remove the **Penguin** to turn **off** the soothing lights or ceiling projector.

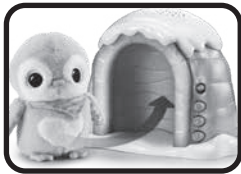



In **Soothing Light** mode, the **Penguin** will activate the **Ceiling Projector**.



In **Projection** mode the **Penguin** will activate **Soothing Light**.

2. Mode Selection

-  Melodies with nature sounds.
-  Calming nature sounds.
-  Lullabies and bedtime melodies.

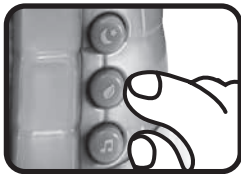

SING-ALONG SONG LYRICS

SONG 1

Twinkle, twinkle, little star,
How I wonder what you are.
Up above the world so high,
Like a diamond in the sky.
Twinkle, twinkle, little star,
How I wonder what you are.

SONG 2

Lullaby and good night, it's time to lay your head down.
Go to sleep my precious child, close your eyes and good night.
Good night, sleep tight, may you dream sweet dreams.
Good night, sleep tight, may you dream sweet dreams.

SONG 3

Penguins really love to play.
Hop and slide and swim all day.
Now it's time to go to bed.
Snuggle down and rest our heads.
Close those sleepy little eyes.
It's time for penguin lullabies.

MELODY LIST:

1. Air - Bach
2. All Through the Night
3. Clair de Lune - Debussy
4. Canon in D - Pachelbel
5. Too-Ra-Loo-Ra-Loo-Ral
6. Diddle Diddle Dumpling
7. Did You Ever See a Lassie?
8. Nocturne op.9 No.2 Arrangement 1 - Chopin
9. Für Elise - Beethoven
10. Good Morning Merry Sunshine
11. Greensleeves - Mozart
12. Happy Farmer - Schumann
13. Hush Little Baby
14. Kinderszenen - Schumann
15. Lullaby - Brahms
16. Magic Flute - Mozart
17. Mary Had a Little Lamb
18. Minuet in G - Bach
19. Hickory Dickory Dock
20. Morning Mood (Peer Gynt) - Grieg
21. New World Symphony - Dvorak
22. Nocturne Op. 9 No. 2 Arrangement 2 - Chopin
23. Ode to Joy - Beethoven
24. Oh, Dear! What Can the Matter Be?
25. Piano Sonata in C, K545 1st Movement - Mozart
26. Prelude - Fugue No. 1 (Well Tempered Clavier) - Bach
27. Ride a Cock Horse to Banbury Cross
28. Roses Are Red
29. Row, Row, Row Your Boat
30. Rock A Bye Baby
31. Sleeping Beauty Waltz - Tchaikovsky
32. Spring Song - Mendelssohn

33. Hey Diddle Diddle
34. Beethoven - Symphony No. 5
35. The Blue Danube Waltz - Strauss
36. The Swan (Carnival of the Animals) - Saint-Saëns
37. To a Wild Rose - MacDowell
38. Winkum, Winkum
39. Eine Kleine Nachtmusik - Mozart
40. Water Musik - Handel

CARE & MAINTENANCE

1. Keep the unit clean by wiping it with a slightly damp cloth, the **Penguin** is machine washable.
2. Keep the unit out of direct sunlight and away from any direct heat sources.
3. Remove the batteries if the unit will not be in use for an extended period of time.
4. Do not drop the unit on hard surfaces and do not expose the unit to moisture or water.

TROUBLESHOOTING

If for some reason the unit stops working or malfunctions, please follow these steps:

1. Please turn the unit **Off**.
2. Interrupt the power supply by removing the batteries.
3. Let the unit stand for a few minutes, then replace the batteries.
4. Turn the unit **On**. The unit should now be ready to use again.
5. If the unit still does not work, install a new set of batteries.

CONSUMER SERVICES

Creating and developing **VTech®** products is accompanied by a responsibility that we at **VTech®** take very seriously. We make every effort to ensure the accuracy of the information, which forms the value of our products. However, errors sometimes can occur. It is important for you to know that we stand behind our products and encourage you to call our Consumer Services Department with any problems and/or suggestions that you might have. A service representative will be happy to help you.

UK Customers:

Phone: 0330 678 0149 (from UK) or +44 330 678 0149 (outside UK)
Website: www.vtech.co.uk/support

Australian Customers:

Phone: 1800 862 155
Website: support.vtech.com.au

NZ Customers:

Phone: 0800 400 785
Website: support.vtech.com.au

PRODUCT WARRANTY/ CONSUMER GUARANTEES

UK Customers:

Read our complete warranty policy online at leapfrog.com/warranty.

Australian Customers:

VTECH ELECTRONICS (AUSTRALIA) PTY LIMITED –
CONSUMER GUARANTEES

Under the Australian Consumer Law, a number of consumer guarantees apply to goods and services supplied by VTech Electronics (Australia) Pty Limited. Please refer to vtech.com.au/consumerguarantees for further information.

**Visit our website for more
information about our products,
downloads, resources and more.**

www.vtech.co.uk
www.vtech.com.au

